



# Induktive Näherungsschalter 8

## Amplified Inductive Sensors 8

3-Draht Sensor / Three-wire sensors  
kurze Bauform / Short housing models  
Kabel- oder Steckergerät / Cable or M8 and M12 quick connect models  
Status LED / Operation LED  
Edelstahlgehäuse / Stainless steel housing



### Bestellschlüssel / Identification code

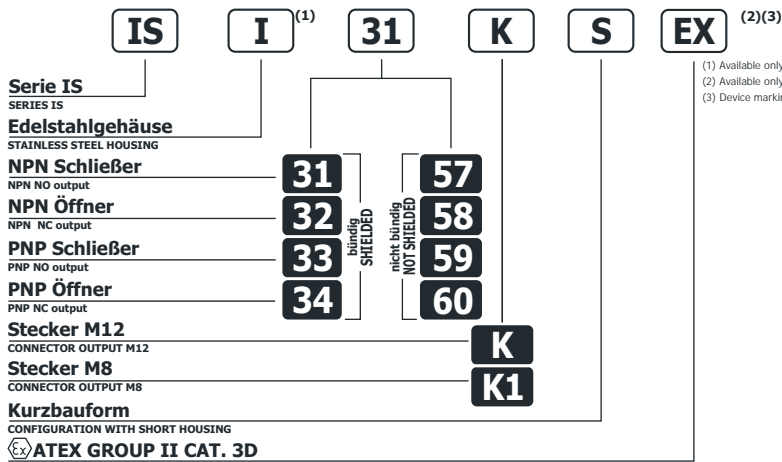

### Anschluss-Schema / Wiring diagrams

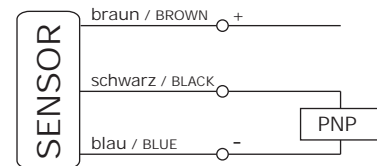
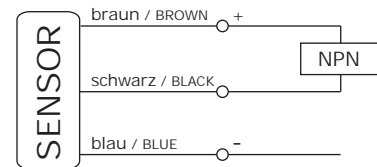

### Anschluss M12 / Connection with connector M12 (K)



- (1) BN braun
- (4) BK schwarz
- (3) BU blau

#### Kontaktbelegung / CONTACTS CONFIGURATION

Ausführung Available	PIN Nummern / Contacts numbers			
	1	2	3	4
NPN / PNP	+		-	NO / NC

### Anschluss M8 / Connection with connector M8 (K1)

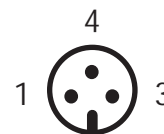

- (1) BN braun
- (4) BK schwarz
- (3) BU blau

#### Kontaktbelegung / CONTACTS CONFIGURATION

Ausführung / Available	PIN Nummern / Contacts numbers		
	1	3	4
NPN / PNP	+	-	NO / NC

### Abmessungen / Dimensions (mm)

Kabelgerät / Configuration with Cable

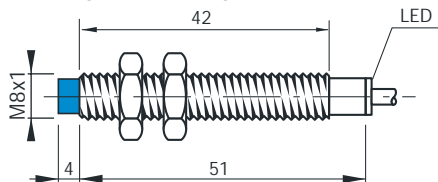

Kurzbauforn / Short Housing

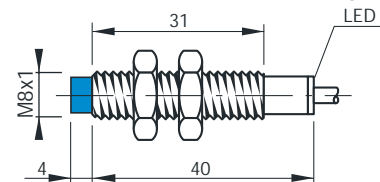

Steckergerät / Connector K

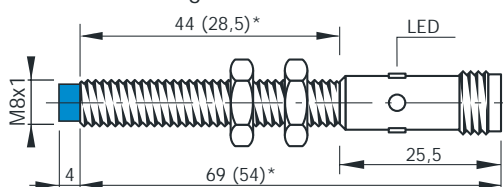

Steckergerät / Connector K1

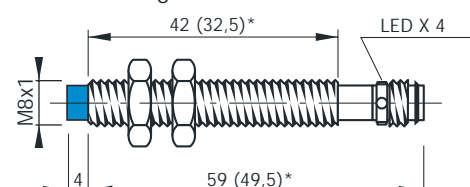

(\*) Die Abmessungen in Klammern entsprechen den Geräten in Kurzbauforn  
The dimensions into brackets refer to short housing models